



NAPOLI STANDARD

Ombrellone robusto e pratico a palo centrale in alluminio verniciato a polveri epossidiche colore grigio antracite. Particolarmente apprezzato da molti anni per la robustezza e compatibilità con qualsiasi ambiente e utilizzo. Palo Diam. 50 mm.

EN

Strong and handy parasol with central pole epoxy coated color anthracite grey. Particularly appreciated for many years for its robustness and compatibility with any environment and use. Pole Diam. 50 mm.





DE

Starker und handlicher Sonnenschirm mit Mittelmast. Farbe Anthrazitgrau pulverbeschichtet. Seit vielen Jahren besonders geschätzt für seine Stabilität und vielfache Verwendungszwecke. Mastdurchmesser 50 mm.

FR

Parasol robuste et pratique avec mat central vernis couleur gris anthracite. Particulièrement apprécié depuis de nombreuses années pour sa robustesse et sa compatibilité avec tous les environnements et toutes les utilisations. Mat diam. 50 mm.

ES

Parasol robusto y práctico de palo central de aluminio pintado con polvo epoxi de color gris antracita. Particularmente apreciado desde hace años por la robustez y compatibilidad con cualquier ambiente y uso. Palo de 50 mm ø.

NL

Sterke en praktische parasol met middenmast. Gepoedercoat in antracietgrijs. Sinds jaar en dag is dit model populair dankzij de goede stabiliteit. Geschikt voor iedere omgeving, dus ook voor de horeca. Doorsnede mast 50 mm.

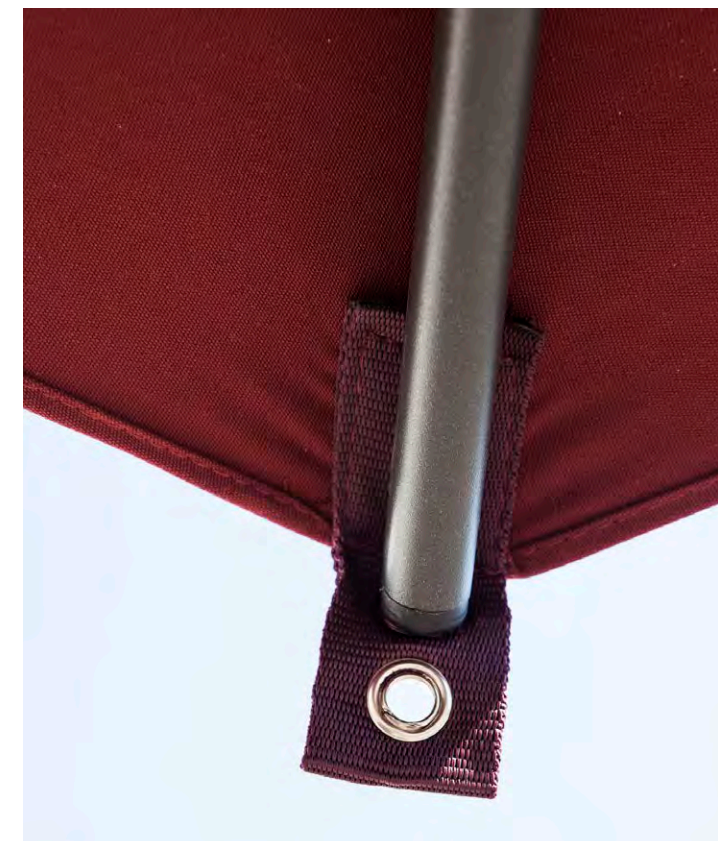

350



300x300



200x300 | 300x400



40

IT

Telaio in alluminio verniciato a polveri colore antracite. Viteria in acciaio inox e componenti in nylon colore nero.

EN

Frame: aluminium powder coated anthracite grey. Stainless steel screws and components in black nylon.

DE

Gestell: Pulverbeschichtetes Aluminium Farbe Anthrazitgrau. Edelstahlschrauben und Zubehör aus Nylon. Farbe schwarz.

FR

Armature: Aluminium vernis couleur gris anthracite. Visserie en inox et composants en nylon noir.

ES

Polvo de aluminio recubierto marco de antracita. Accesorios de nylon. Tornillo de aciere inox y componentes de nylon negro.

NL

Mast en baleinen: aluminium, antracietgrijs geëpoxideerd. Schroeven van RVS, overige bewegende delen zijn van nylon.



41

CHARACTERISTICS



3,5
C3500 NAS

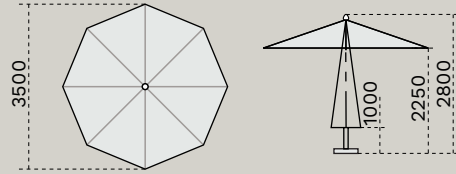

15 0,10 50 8 18x30

3,0 x 3,0
C3030 NAS

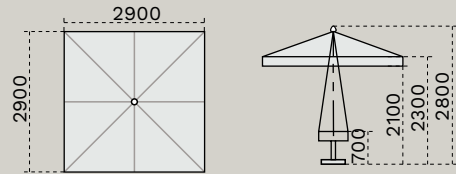

15 0,11 50 8 18x30

2,0 x 3,0
C2030 NAS

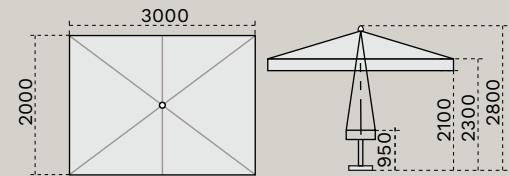

14 0,14 50 6 18x30

3,0 x 4,0
C3040 NAS

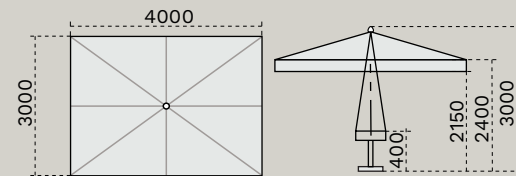

18 0,12 50 8 18x30

FINISHING



• Camino antivento
Wind cap



• Alu Dark



• Stecca con sistema "easy change"
Ribs with "easy change" system



• Alu Dark



• Doppia Carrucola
Double pulley

OPTIONAL

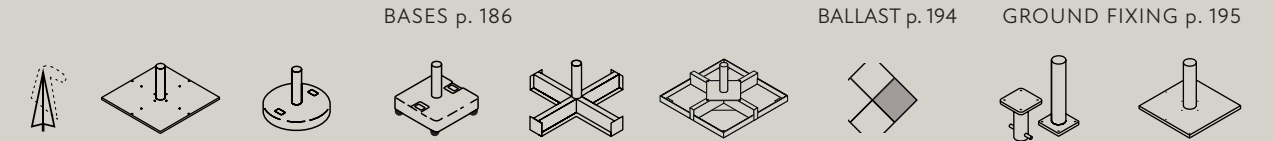

3,5
C3500 NAS



BF6565D
BF6666D

BC55MA4
BC80MA4

BC151GRA4

/

/

/

BTC
+BTT55

CP3030ZS
+BTT55

3,0 x 3,0
C3030 NAS



BF6565D
BF6666D

BC55MA4
BC80MA4

BC151GRA4

BQ8080DS

BUD8080DS



BTC
+BTT55

CP3030ZS
+BTT55

2,0 x 3,0
C2030 NAS



BF6565D
BF6666D

BC55MA4
BC80MA4

BC151GRA4

/

/

/

BTC
+BTT55

CP3030ZS
+BTT55

3,0 x 4,0
C3040 NAS



BF6565D
BF6666D

BC55MA4
BC80MA4

/

BQ8080DS

BUD8080DS



BTC
+BTT55

CP3030ZS
+BTT55

COLOUR RANGE - p.204

ACRILYC 350GR

Con volante / with volant



A1S

C3030 NAS

C2030 NAS

C3040 NAS

Senza volante / without volant



A1N

ALL OPTIONS



T2N

T3N

C3500 NAS



T2S

T3S

C3030 NAS

C3040 NAS



T6N

T7N

C3500 NAS

C3030 NAS

C3040 NAS



T8N

T9N





S1N

BASES STANDARD / TELESCOPIC







BT45 - BT55 - BT65

- Tubo in acciaio zincato. Doppio galletto. Viteria inclusa.
- Steel zinced tube. Double wing nut. Screws included.
- Verzinkte Stahlhülse. Doppelte Hutmutter. Schrauben inbegriffen.
- Tube acier zingué. Avec écrou papillon. Visserie incl.
- Tubo de acero galvanizado. Los tornillos incluidos.
- Koker gegalvaniseerd. Inclusief schroeven.

				KG 
BT45	42 mm	45 mm	36-40 mm	1 Kg
BT55	52 mm	55 mm	47-50 mm	
BT65	62 mm	65 mm	55-60 mm	



BTT45 - BTT55 - BTT65

- Tubo acciaio per fissaggio a terra. Eventualmente da abbinare all'articolo BTC.
- Steel tube for ground fixing. Possibility to combine it with Art BTC.
- Stahlhülse fuer Bodenbefestigung. Eventuell mit Art BTC kombinierbar.
- Tube en acier pour fixation au sol. Eventuellement à joindre avec BTC.
- Tubo de acero para sujeción al suelo. Posiblemente para que coincida con el artículo BTC.
- Metalen koker voor betonanker. Te gebruiken in combinatie met artikel BTC.

				KG 
BTT45	42 mm	45 mm	36-40 mm	1 Kg
BTT55	52 mm	55 mm	47-50 mm	
BTT65	62 mm	65 mm	55-60 mm	

BTC



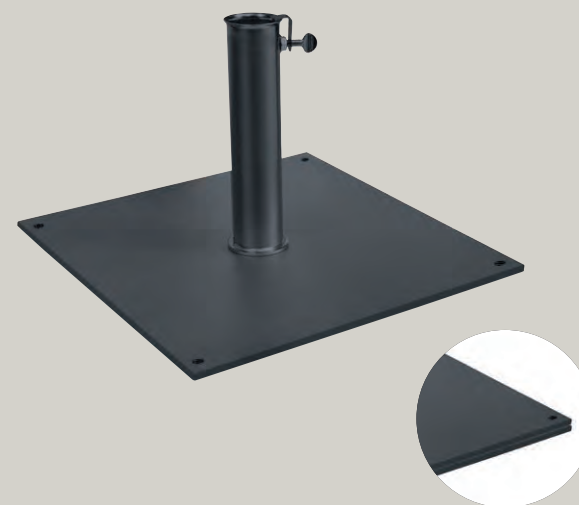

- Supporto da interrare. Da abbinare a BTT55 e BTT65.
- supporta for ground fixing. To combine with BTT55 and BTT65.
- Staender zum einbetonieren. Kombinierbar mit BTT55 und BTT65.
- Pied pour fixation au sol. A joindre avec BTT55 et BTT65.
- Pie para fijar al suelo. Combinar con BTT55 y BTT65.
- Betonanker, te gebruiken in combinatie met BTT55 en BTT65.

		KG 
BTC	47-50 mm	1,3 Kg







BF6565D - BF6666D

- Base in acciaio colore antracite. Tubo incl.
- Steel base colour antracite grey. Tube incl.
- Stahlstaender grau pulverbeschichtet. Hülse inbegriffen.
- Pied en acier vernis coul. gris. Tube incl.
- Pie de acero de color antracita. Tubo incluido.
- Parasolvoet grijs geëpoxeerde metaalplaat. Wordt geleverd met koker.

					KG 
BF6565D/T45	650x650x15 mm	42 mm	45 mm	36-40 mm	35 Kg
BF6565D/T55		52 mm	55 mm	47-50 mm	
BF6565D/T65		62 mm	65 mm	55-60 mm	
BF6666D/T45	650x650x25 mm	42 mm	45 mm	36-40 mm	70 kg
BF6666D/T55		52 mm	55 mm	47-50 mm	
BF6666D/T65		62 mm	65 mm	55-60 mm	





BF6565W - BF6666W **NEW**

- Base in acciaio Starwhite. Tubo incl.
- Starwhite finish steel base. Tube included.
- Stahlstaender pulverbeschichtet Farbe weiss. Hülse inbegriffen.
- Pied en acier vernis Starwhite. Tube inclus.
- Base de acero pintado Starwhite. Tubo incluido.
- Parasolvoet metaal in witte kleur. Wordt geleverd met koker.

					KG 
BF6565W/T45	650x650x15 mm	42 mm	45 mm	36-40 mm	35 Kg
BF6565W/T55		52 mm	55 mm	47-50 mm	
BF6565W/T65		62 mm	65 mm	55-60 mm	
BF6666W/T45	650x650x25 mm	42 mm	45 mm	36-40 mm	70 kg
BF6666W/T55		52 mm	55 mm	47-50 mm	
BF6666W/T65		62 mm	65 mm	55-60 mm	



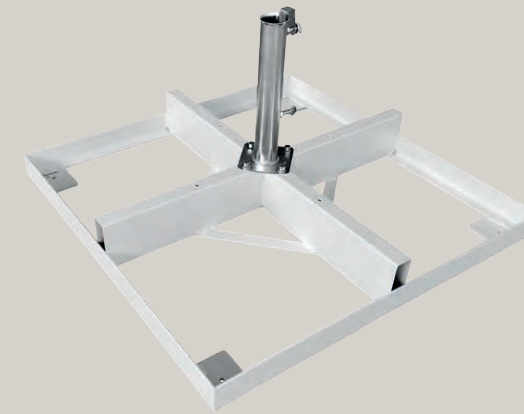

**BQ8080ZS**

- Base a croce metallica zincata. Disponibile con BTT55 e BTT65. Tubo incluso. Da abbinare a 8 piastre cemento Art.BC4040
- Zinced cross metal base. Available with BTT55 and BTT65. Tube included. To combine with 8 cement plates Art.BC4040
- Verzinkte Stahlplattenstaender. Verfuegbar mit BTT55 und BTT65. Huelse inbegriffen. Zum kombinieren mit 8 Betonplatten Art.BC4040
- Pied en acier galvanisé. Disponible avec BTT55 et BTT65. Tube incl. À combiner avec 8 dalles ciment Art.BC4040
- Base de metal galvanizado. Disponible con BTT55 y BTT65. Tubo incluido. Para combinar con 8 placas de hormigón Art.BC4040
- Metalen basis, verzinkt. Verkrijgbaar met BTT55 en BTT65. Tube inbegrepen. Te combineren met 8 betonplaten Art.BC4040

					
BQ8080ZS/T55	850x850 mm	52 mm	55 mm	47-50 mm	8 Kg
BQ8080ZS/T65		62 mm	65 mm	55-60 mm	



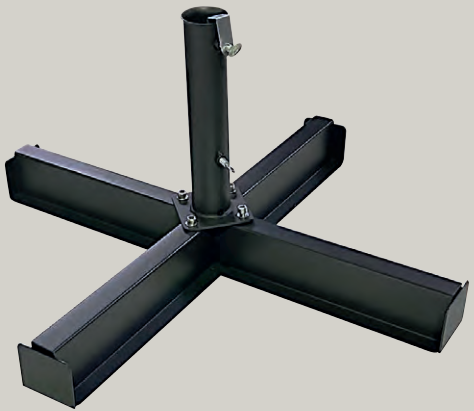

**BUD8080BS**

- Base a croce metallica colore bianco Starwhite. Disponibile con BTT55 e BTT65. Tubo incluso. Da abbinare a 12 piastre cemento Art.BC4040
- White cross metal base. Available with BTT55 and BTT65. Tube included. To combine with 12 cement plates Art.BC4040
- Weisser Stahlplattenstaender. Verfuegbar mit BTT55 und BTT65. Huelse inbegriffen. Zum kombinieren mit 12 Betonplatten Art.BC4040
- Pied en acier blanc. Disponible avec BTT55 et BTT65. Tube incl. À combiner avec 12 dalles ciment Art.BC4040
- Base de metal blanca. Disponible con BTT55 y BTT65. Tubo incluido. Para combinar con 12 placas de hormigón Art.BC4040
- Wit metalen basis. Verkrijgbaar met BTT55 en BTT65. Tube inbegrepen. Te combineren met 12 betonplaten Art.BC4040

					
BUD8080BS/T55	850x850 mm	52 mm	55 mm	47-50 mm	32 Kg
BUD8080BS/T65		62 mm	65 mm	55-60 mm	



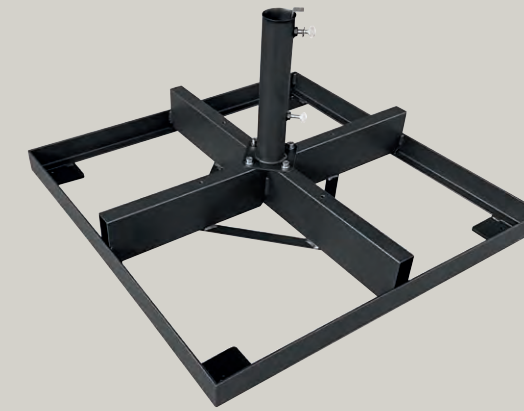

**BQ8080DS**

- Base a croce metallica colore antracite. Disponibile con BTT55 e BTT65. Tubo incluso. Da abbinare a 8 piastre cemento Art.BC4040
- Dark cross metal base. Available with BTT55 and BTT65. Tube included. To combine with 8 cement plates Art.BC4040
- Stahlplattenstaender. Anthrazitgrau. Verfuegbar mit BTT55 und BTT65. Huelse inbegriffen. Zum kombinieren mit 8 Betonplatten Art.BC4040
- Pied en acier gris. Disponible avec BTT55 et BTT65. Tube incl. À combiner avec 8 dalles ciment Art.BC4040
- Base de metal gris. Disponible con BTT55 y BTT65. Tubo incluido. Para combinar con 8 placas de hormigón Art.BC4040
- Metalen basis. Houtskoolgrijs. Verkrijgbaar met BTT55 en BTT65. Tube inbegrepen. Te combineren met 8 betonplaten Art.BC4040

					
BQ8080DS/T55	850x850 mm	52 mm	55 mm	47-50 mm	8 Kg
BQ8080DS/T65		62 mm	65 mm	55-60 mm	

**BUD8080DS**

- Base a croce metallica colore antracite. Disponibile con BTT55 e BTT65. Tubo incluso. Da abbinare a 12 piastre cemento Art.BC4040
- Dark cross metal base. Available with BTT55 and BTT65. Tube included. To combine with 12 cement plates Art.BC4040
- Stahlplattenstaender anthrazitgrau. Verfuegbar mit BTT55 und BTT65. Huelse inbegriffen. Zum kombinieren mit 12 Betonplatten Art.BC4040
- Pied en acier gris. Disponible avec BTT55 et BTT65. Tube incl. À combiner avec 12 dalles ciment Art.BC4040
- Base de metal gris. Disponible con BTT55 y BTT65. Tubo incluido. Para combinar con 12 placas de hormigón Art.BC4040
- Metalen basis. Houtskoolgrijs. Verkrijgbaar met BTT55 en BTT65. Tube inbegrepen. Te combineren met 12 betonplaten Art.BC4040

					
BUD8080DS/T55	850x850 mm	52 mm	55 mm	47-50 mm	32 Kg
BUD8080DS/T65		62 mm	65 mm	55-60 mm	

BC35MA4 **NEW**



- Base in cemento graniglia bianca con maniglie. Disponibile con tubo BTT45, BTT55, BTT65. Tubo incluso.
- White cement grit base with handles. Available with tube BTT45, BTT55, BTT65. Tube incl.
- Weisser Kiesbetonstaender mit Handgriffen. Verfuegbar mit Huelse BTT45, BTT55, BTT65. Huelse inbegr.
- Pied ciment grés blanc avec poignées. Disponible avec tube BTT45, BTT55, BTT65. Tube incl.
- Base de cemento y arena blanca con asas. Disponible con tubo BTT45, BTT55, BTT65. Tubo incluido.
- Wit parasolvoet gewassen grind met handgrepen. Inclusief koker, maat naar keuze: BTT45, BTT55, BTT65.



		42 mm	45 mm	36-40 mm	
BC35MA4/T45					
BC35MA4/T55	Ø 540 mm	52 mm	55 mm	47-50 mm	35 Kg
BC35MA4/T65		62 mm	65 mm	55-60 mm	

BC55MA4/BC80MA4



- Base in cemento graniglia bianca con maniglie. Disponibile con tubo BTT45, BTT55, BTT65. Tubo incluso.
- White cement grit base with handles. Available with tube BTT45, BTT55, BTT65. Tube incl.
- Weisser Kiesbetonstaender mit Handgriffen. Verfuegbar mit Huelse BTT45, BTT55, BTT65. Huelse inbegr.
- Pied ciment grés blanc avec poignées. Disponible avec tube BTT45, BTT55, BTT65. Tube incl.
- Base de cemento y arena blanca con asas. Disponible con tubo BTT45, BTT55, BTT65. Tubo incluido.
- Wit parasolvoet gewassen grind met handgrepen. Inclusief koker, maat naar keuze: BTT45, BTT55, BTT65.



		42 mm	45 mm	36-40 mm	
BC55MA4/T45					
BC55MA4/T55	Ø 600 mm	52 mm	55 mm	47-50 mm	55 Kg
BC55MA4/T65		62 mm	65 mm	55-60 mm	
BC80MA4/T45		42 mm	45 mm	36-40 mm	
BC80MA4/T55	Ø 640 mm	52 mm	55 mm	47-50 mm	80 Kg
BC80MA4/T65		62 mm	65 mm	55-60 mm	

BC5151GRA4



- Piastra in cemento grigio con maniglie. Disponibile con tubo BTT45, BTT55, BTT65. Tubo incluso.
- Concrete grey cement slab with handles. Available with tube BTT45, BTT55, BTT65. Tube incl.
- Grauer Betonplatte mit Handgriffen. Verfuegbar mit Huelse BTT45, BTT55, BTT65. Huelse inbegr.
- Dalles ciment couleur gris avec poignées. Disponible avec tube BTT45, BTT55, BTT65. Tube incl.
- Base de cemento gris con asas. Disponible con tubo BTT45, BTT55, BTT65. Tubo incluido.
- Betontegel grijs met handgrepen. Inclusief koker, maat naar keuze: BTT45, BTT55, BTT65.



		42 mm	45 mm	36-40 mm	
BC5151GRA4/T45					
BC5151GRA4/T55	500x500 mm	52 mm	55 mm	47-50 mm	60 Kg
BC5151GRA4/T65		62 mm	65 mm	55-60 mm	



La base e l'eventuale zavorra sono fondamentali per garantire stabilità e sicurezza. Selezionare l'opzione adeguata al momento dell'ordine. In caso di fissaggio a terra si esclude il rischio di ribaltamento dell'ombrellone, ma non il cedimento strutturale di alcuni componenti se sottoposti a condizioni atmosferiche incompatibili con l'uso dei ns prodotti. Queste tabelle sono indicative e prevedono che il pavimento o il terreno di appoggio sia perfettamente piano e regolare. Gli ombrelloni e i rispettivi componenti delle basi devono essere assemblati correttamente rispettando le istruzioni di montaggio. La stabilità degli ombrelloni può variare nel caso di condizioni atmosferiche particolari. L'utilizzatore finale è responsabile del corretto uso dell'ombrellone. Nessuna rivalsa può essere fatta sul produttore.

EN

The base and any ballast are essential to ensure stability and safety. Please select the appropriate option when ordering. In case of ground fixation, the risk of overturning of the parasol is excluded, but not the structural failure of some components, if subjected to atmospheric conditions that are incompatible with the use of our products. This schedule considers statics calculation and foresees that the floor where the parasol has to be positioned is perfectly flat and regular. The parasols and components have to be assembled correctly and respecting the assembly instruction. The schedule has to be considered indicative because many variables that depend from the area of employ and position of the parasols are not foreseeable. No rights can be derived from this. The use of a parasol is always on your own responsibility.



DE

Der Staender und eventueller Ballast sind grundlegend um Stabilitaet und Sicherheit zu gewaehrleisten. Bitte waehlen Sie bei der Bestellung die entsprechende Option aus.

Bei Bodenbefestigung ist das Risiko des Umkippens des Schirms ausgeschlossen, aber nicht das strukturelle Versagen einiger Bestandteile, wenn es atmosphärischen Bedingungen ausgesetzt wird, die mit der Verwendung unserer Produkte nicht vereinbar sind. Diese Aufstellung beinhaltet statistische Kalkulationen und sieht vor, dass der Schirm auf einem ebenen und regelmaessigen Boden positioniert wird. Der Schirm und die Bestandteile des Staenders muessen gemaess Anbauanleitungen montiert werden. Die Stabilitaet der Schirme kann auf Grund besonderer klimatischen Konditionen aendern. Der Endbenutzer ist fuer die ordnungsgemaesse Verwendung des Schirmes verantwortlich.

FR

La base et les eventuels poids sont essentiels pour assurer la stabilité et la sécurité. Svpl. sélectionnez l'option appropriée lors de la commande. En cas de fixation au sol, le risque de renversement du parasol est exclu, mais pas la défaillance structurelle de certains composants s'ils sont soumis à des conditions atmosphériques incompatibles avec l'utilisation de nos produits. Ces tableaux sont à titre indicatif et ils prévoient que la surface sur laquelle est implanté le parasol soit parfaitement plane et lisse. Les parasols et les éléments respectifs des bases doivent être assemblés en respectant scrupuleusement les instructions de montage. La stabilité des parasols peut varier dans le cas de conditions atmosphériques particulières et dépend du lieu et de l'utilisation propre à chaque utilisateur (le parasol doit être fermé en cas de vent fort et/ou de mauvaises conditions météorologiques).

ES

La base y posible balasto son fundamentales para garantizar la estabilidad y la seguridad. Seleccione la opción adecuada al realizar el pedido. En caso de fijación al suelo, se excluye el riesgo de vuelco del parasol, pero no el fallo estructural de algunos componentes si se someten a condiciones atmosféricas incompatibles con el uso de nuestros productos. Estos cuadros son indicativos y requieren que el suelo o el apoyo de tierra sea perfectamente plano y liso. El parasol y los respectivos componentes de la base deben ser montados correctamente respetando las instrucciones. La estabilidad de los parasoles puede variar según las condiciones atmosféricas.

NL

Basis en eventuele ballast zijn essentieel om stabiliteit en veiligheid te garanderen. Selecteer alstublieft de juiste optie bij het bestellen. In het geval van bevestiging aan de grond is het risico dat de parasol omvalt uitgesloten, maar niet het structurele falen van sommige onderdelen als ze worden blootgesteld aan atmosferische omstandigheden die onverenigbaar zijn met het gebruik van onze producten. Dit schema houdt rekening met statische berekeningen en gaat ervan uit dat de vloer waarop de parasol moet worden geplaatst perfect vlak en regelmatig is. De parasols en onderdelen moeten correct en volgens de montagehandleiding worden gemonteerd. Het schema moet als indicatief worden beschouwd omdat veel variabelen die afhangen van het werkgebied en de positie van de parasols niet te voorzien zijn.

STABILITY

1

- Peso minimo richiesto
- Minimum required weight
- Erforderliches Mindestgewicht
- Poids minimum requis
- Peso mínimo requerido
- Minimaal vereist gewicht

2

- Stabilità intermedia
- Intermediate stability
- Mittlere Stabilität
- Stabilité intermédiaire
- Estabilidad intermedia
- Gemiddelde stabiliteit

3

- Peso consigliato in condizioni normali
- Recommended weight under normal conditions
- Empfohlenes Gewicht unter normalen Bedingungen
- Poids recommandé dans des conditions normales
- Peso recomendado en condiciones normales
- Aanbevolen gewicht onder normale omstandigheden

4

- Massima stabilità con base
- Maximum stability with base
- Maximale Stabilität mit Staender
- Stabilité maximale avec socle
- Máxima estabilidad con base
- Maximale stabiliteit met voet

5

- Massima stabilità con fissaggio a terra
- Maximum stability with ground fixation
- Maximale Stabilität bei Bodenbefestigung
- Stabilité maximale avec fixation au sol
- Máxima estabilidad con fijación al suelo
- Maximale stabiliteit door bodembevestiging



- In caso di base con ruote, prestare particolare attenzione in caso di vento. Prima di spostare l'ombrellone è necessario chiuderlo.
- In case of base with wheels, be especially careful in windy conditions. Close the parasol before moving it.
- Bei Staender mit Raeder und Wind besonders vorsichtig sein. Der Schirm kann geschlossen bewegt werden.
- Dans le cas d'une base à roues, faites particulièrement attention par temps venteux. Avant de déplacer le parasol, il est nécessaire de le fermer.
- En el caso de una base con ruedas, tenga especial cuidado en condiciones de viento. Antes de mover la sombrilla es necesario cerrarlo.
- Wees vooral voorzichtig met statieven met wielen en wind. De parasol kan in gesloten toestand worden verplaatst.

		BASES						GROUND FIXING			
		BC35MA4	BC55MA4	BC80MA4	BC5151GRA4	BF6565D BF6565W	BF6666D BF6666W	BUD8080 +N°12 BC4040	BQ8080 +N°8 BC4040	BTC +BTT	CP3030ZS +BTT
PALLADIO	Ø 2,5	1	3	4		3	4	/	/	5	5
LIDO		1	3	4		3	4	/	/	5	5
PALLADIO	Ø 3,0	/	3	4		3	4	/	/	5	5
NAPOLI RIMINI	Ø 3,5	/	2	3		2	3	/	4	5	5
PALLADIO		/	2	3		2	3	/	4	5	5
PALLADIO	Ø 4,0	/	1	2	/	1	2	4	3	5	5
PALLADIO TEL.	Ø 5,0	/	/	1	/	/	1	3	2	5	5
VELA LIDO	2,0 x 2,0	1	3	4		3	4	/	/	5	5
PALLADIO		1	3	4		3	4	/	/	5	5
VELA		/	2	3		2	3	5	4	5	5
PALLADIO	3,0 x 3,0	/	2	3		2	3	5	4	5	5
NAPOLI RIMINI		/	2	3		2	3	5	4	5	5
PALLADIO	3,5 x 3,5	/	1	2	/	1	2	4	3	5	5
LEONARDO		/	1	2	/	1	2	4	3	5	5
PALLADIO	4,0 x 4,0	/	/	1	/	/	1	4	3	5	5
LEONARDO PALLADIO TEL.		/	/	1	/	/	1	4	3	5	5
NAPOLI	2,0 x 3,0	/	3	4		3	4	/	/	5	5
PALLADIO		/	3	4		3	4	/	/	5	5
NAPOLI RIMINI		/	1	2	/	1	2	4	3	5	5
PALLADIO	3,0 x 4,0	/	1	2	/	1	2	4	3	5	5
LEONARDO PALLADIO TEL.		/	1	2	/	1	2	4	3	5	5

MATERIALI E FINITURE

MATERIALS AND FINISHING

COMPONENTI E PROFILI ALLUMINIO

ALUMINIUM COMPONENTS AND PROFILES



ALUMINIUM DARK

- Napoli Standard / Braccio
- Leonardo Braccio / Telesc.
- Palladio Braccio
- Torino Braccio
- Galileo Dark
- Galileo Maxi Dark
- Alu Poker / Double Dark
- Wood Poker / Double
- Capri Dark
- Lido



ALUMINIUM STARWHITE

- Rimini standard
- Rimini Braccio
- Pompei
- Galileo
- Galileo Maxi
- Capri
- Lido

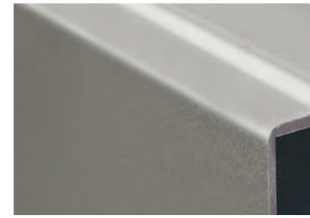

ALU TITANIUM

- Lido Titanium
- Vela Titanium



ALUMINIUM IROKO

- Torino Braccio
- Palladio Braccio
- Wood Double
- Galileo Wood



ACCESSORIES



ALUMINIUM DARK

- Napoli Standard / Braccio
- Leonardo Braccio/Telescopic
- Galileo Dark
- Galileo Maxi Dark
- Alu Poker / Double Dark
- Lido



ALUMINIUM STARWHITE

- Rimini standard
- Rimini Braccio
- Pompei
- Galileo
- Galileo Maxi
- Lido



ALU TITANIUM

- Lido Titanium
- Vela Titanium



ALU IROKO

- Galileo Wood



IROKO WOOD

- Palladio Standard
- Palladio Braccio
- Palladio Telescopic
- Torino



Standard

Galileo

Braccio

FABRIC COLLECTION



FATTORE DI PROTEZIONE SOLARE

Limita il passaggio del calore per più del 70%.

SOLAR PROTECTION FACTOR

Harmful UV rays and limiting heat circulation



FATTORE DI PROTEZIONE LUMINOSA

Indica la percentuale di trasmissione della luce

FACTOR OF SOLAR LIGHT PROTECTION

% of light transmission



FATTORE DI PROTEZIONE UPF

Protezione dai raggi U.V. (UPF) dal 85% al 100%

UPF PROTECTION FACTOR

Harmful UV rays. (UPF) from 85% almost 100%

SCHEMA TECNICA / DATA SHEET

COMPOSIZIONE / COMPOSITION	CARATTERISTICHE / FINISHING	SOLIDITÀ AL COLORE / COLOR FASTNESS	TRATTAMENTO / TREATMENT	IMPERMEABILITÀ / COLONNA D'ACQUA IMPERMEABILITY / WATER COLUMN
350 gr/m ² 100% acryl	Inattaccabile da muffe e batteri. Solido alla luce Permeabile all'aria Antimacchia - Resistant to mould and bacteria. Solid to light Air permeable Stain resistant	Grado 7/8 ensio 105-b04 - Grade 7/8 ensio 105-b04	Resine teflon idro-oleorepellenza - Teflon resins water-oil repellent	circa 25 cm - about 25cm

204

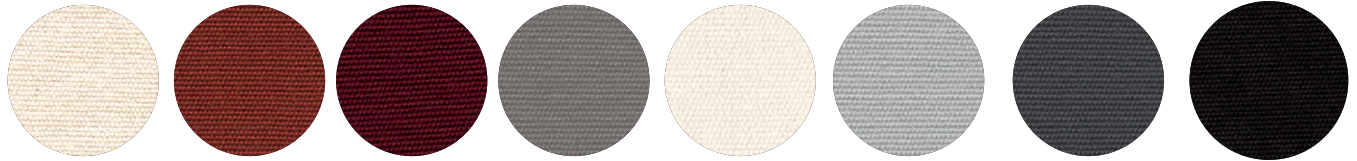

350 GR/M²
ACRYLIC

A1	T2	T3	T6	T7	T8	T9	S1
ECRU NATURAL COL. NATUR	TERRACOTTA ZIEGELROT TERRACOTTA	BORDEAUX	GRIGIO TAUPE GREY TAUPE GRAU TAUPE GRIS TAUPE GRIJS TAUPE	BIANCO WHITE BLANC WEISS	GRIGIO PERLA SILVER GREY SILBERGRAU	GRIGIO ANTRACITE ANTHRACIT GREY ANTHRAZITGRAU	NERO /BLACK SCHWARZ NOIRE NEGRO ZWART



70/80% > 90% > 90% > 90% 70/80% > 90% > 90% > 90%



20/30% < 10% < 10% < 10% 20/30% < 10% < 10% < 10%



85/89% 100% 100% 100% 85/89% 100% 100% 100%

I dati forniti, pur essendo frutto di misurazioni scientifiche condotte in laboratori certificati, sono da ritenersi indicativi.
The above mentioned data are indicative, although provided by scientific measurements performed in certified laboratories.



USO E MANUTENZIONE

INDICAZIONI

- Prima dell'uso, conservare e leggere attentamente i manuali e le istruzioni di montaggio che si trovano all'interno della confezione.
- La base deve essere zavorrata. Un peso insufficiente compromette seriamente la stabilità dell'ombrellone.
- Rimuovere sempre la manovella quando non in uso e tenerla fuori dalla portata dei bambini.
- Per evitare danni o lesioni personali, l'ombrellone deve essere chiuso e in alcune condizioni atmosferiche avverse potrebbe essere necessario rimuovere il prodotto e stoccarlo in luogo protetto. Ricorda sempre che l'ombrellone non è una costruzione fissa. La ditta Scolaro non può essere ritenuta responsabile per danni alla merce fornita, o lesioni derivanti da un uso improprio e dal mancato rispetto delle istruzioni e delle linee guida fornite.

IMPIEGO DEL PRODOTTO

Prima di iniziare ad aprire l'ombrellone, assicurarsi che il tessuto non sia rimasto impigliato nelle stecche interne. Per aprire o chiudere l'ombrellone ruotare la maniglia (dove presente) nel senso indicato dalle frecce e dalla scritta "Apri" o "Chiudi". Un funzionamento errato potrebbe strappare la corda o danneggiare il meccanismo. Non forzare mai le corde o maniglie. Se si bloccano, controlla perché è successo ed elimina la possibile causa.

Parti in legno: applicare un impregnante per legno a base di cera almeno una volta all'anno prima della stagione invernale. Chiudere l'ombrellone quando le condizioni meteorologicxhe non sono adatte, ad es. forte vento o pioggia battente.

Gli ombrelloni Scolaro possono essere abbinati a basi speciali sviluppate per il fissaggio a terra. Qualora si decida di posizionare un ombrellone Scolaro utilizzando solo zavorra, ne viene certificata l'idoneità all'utilizzo in condizioni di vento moderato. Nella tabella specifica sono indicate le zavorre minime. Il Cliente è l'unico responsabile dell'installazione e della gestione dell'ombrellone.

ACCIAIO INOSSIDABILE

Attenzione:

1. NON UTILIZZARE I SEGUENTI PRODOTTI su parti in acciaio inossidabile: Candeggina a base di cloro o detersivi contenenti candeggina (possono corrodere l'acciaio inossidabile). Acido cloridrico o prodotti contenenti cloruri (possono corrodere l'acciaio inossidabile).
2. Il sale, il calcare o gli acidi (bevande e alimenti) possono scolorire le parti in acciaio inossidabile se non pulite tempestivamente.
3. I prodotti o le parti in acciaio inossidabile utilizzati in prossimità del mare o per la decorazione interna delle piscine richiedono una pulizia più frequente per rimuovere i cloriti depositati e per prevenire la corrosione e il deterioramento chimico delle superfici esterne.
4. Macchie o ruggine rilevate sulle superfici in acciaio inossidabile devono essere pulite tempestivamente.
5. Le macchie non rimosse per lunghi periodi possono diventare permanenti.
6. La ruggine può causare reazioni chimiche o corrodere l'acciaio inossidabile.

Per rimuovere macchie o ruggine:

- Applicare un detersivo o lucidante specifico non abrasivo per acciaio inox.
- Sciacquare accuratamente con acqua pulita.
- Infine asciugare bene per evitare che si formino striature, sfregamento nel senso delle fibre.

METALLI VERNICIATI: FERRO E ALLUMINIO

Per una lunga durata dell'ombrellone si consiglia di riporlo in ambienti asciutti, durante il periodo invernale e quando non utilizzato. Si consiglia inoltre di controllare una volta a stagione, soprattutto dopo un lungo periodo di inattività, il corretto funzionamento di tutti i componenti. La nostra garanzia non copre alcun tipo di graffio o abrasione alla finitura causata dal contatto con altri arredi o dalla conseguente corrosione.

L'impiego in ambienti marini può portare all'accumulo di sali e cloruri sulla verniciatura a polvere. La mancata esecuzione di una regolare pulizia con acqua dolce può causare la formazione di bolle, ossidazioni, scolorimento e invalidare la garanzia.

Per la pulizia delle superfici in metallo verniciato utilizzare acqua fredda e detersivi liquidi non abrasivi o aggressivi. Applicare con un panno morbido. Nel caso di superfici molto sporche e/o invecchiate, dopo la pulizia, si consiglia di trattarle con paraffina liquida. In caso di macchie causate da depositi di calcare su vernici di struttura grossolana (es. ferro antico e marrone d'india) pulirle con uno straccio e una soluzione di aceto di vino bianco diluito in acqua fredda.

LEGNO: IROKO

Legno tradizionale impiegato per l'arredo esterno e l'industria nautica. L'Iroko è un legno duro ad alto contenuto di olio, adatto per uso esterno. Estremamente duraturo. È praticamente inalterabile alla ripetuta esposizione agli agenti atmosferici. Anche se trattato, la superficie assume una patina grigio argento che è la naturale protezione dall'interno del legno, considerato parte essenziale del fascino dell'Iroko. La naturale tendenza del legno ad ingrigire o perdere la brillantezza della vernice può essere prevenuta nelle prime fasi di vita del prodotto. L'ombrellone può essere ripristinato mediante un nuovo trattamento con adeguato prodotti facilmente reperibili nei negozi specializzati. È necessario applicare una soluzione di acqua e olio incolore, a superfici esposte con un panno. L'olio deve essere molto diluito. Le macchie superficiali possono essere rimosse intervenendo per tempo, prima che il legno possa assorbirle completamente. Carteggiare delicatamente la superficie in questione e poi lucidare con un panno ruvido.

TESSUTI SINTETICI: ACRILICO E POLIESTERE

Il tessuto è impermeabile e trattato antimuffa per respingere l'acqua, le macchie e garantire la traspirazione. Si prega di seguire le nostre istruzioni di manutenzione per garantire la lunga durata del tessuto:

- Rimuovere spesso depositi di polvere, macchie e qualsiasi tipo di sporco per evitare tracce dopo la pulizia.
- È molto importante chiudere l'ombrellone solo quando è perfettamente asciutto. Durante l'inverno e quando l'ombrellone non viene utilizzato, deve essere conservato in un ambiente asciutto. Evitare il contatto prolungato con sostanze oleose e/o coloranti che potrebbero essere assorbite dal materiale di rivestimento in PVC e causare macchie permanenti, oltre a danneggiare la struttura del filo. Non utilizzare solventi o detersivi a base di solventi (evitare l'acetone). Usare acqua e detersivi liquidi non abrasivi, incolore, a PH neutro. Lasciare agire il detersivo per qualche minuto. Risciacquare bene con acqua non più calda di 30°C.

COMPONENTI

I componenti in acciaio, la viteria e gli accessori sono trattati antiruggine. Comunque per una lunga durata dell'ombrellone, durante l'inverno e quando non viene utilizzato, l'ombrellone deve essere conservato in ambiente asciutto. Durante ogni stagione è necessario verificare la funzionalità di tutti i componenti, soprattutto dopo un lungo periodo di inattività. La ditta Scolaro è a vostra disposizione per assistenza tecnica.

GARANZIA

Gli ombrelloni Scolaro sono progettati per durare molti anni esposti all'uso esterno.

Come per molti articoli, l'attenzione nell'uso e nella manutenzione e il rispetto delle istruzioni contenute in queste pagine, permette una vita media ancora più lunga del prodotto e la possibilità di godere di un prodotto ancora più efficiente ed esteticamente gradevole.

I prodotti Scolaro sono garantiti 2 anni.

Se si rispettano le indicazioni e i consigli, la garanzia può essere estesa come segue:

LA GARANZIA COPRE SOLO I DIFETTI DI FABBRICAZIONE DI INTEGRITÀ STRUTTURALE. LA GARANZIA NON COPRE DANNI CAUSATI DA AZIONI MECCANICHE, FORZA NATURALE E ATTI DOLOSI.

5 anni di garanzia sui componenti in alluminio e acciaio inox. Inclusa verniciatura e viti.

- Difetti strutturali non derivanti da uso improprio o mancata manutenzione.
- Corrosione invasiva non prodotta da graffi o abrasioni da utilizzo non asportabile mediante normale pulizia e manutenzione.

5 anni di garanzia sui colori e sul trattamento dei tessuti (resistenza).

- La sostituzione della coperta durante il periodo di garanzia è prevista solo in caso di scolorimento prima della fine del periodo di garanzia. Gli utenti devono conservare correttamente i tessuti, affinché la garanzia sia effettiva. Una corretta manutenzione implica una pulizia regolare.
- La garanzia non copre i danni da contatto con oggetti estranei, abrasioni causate dal vento, uso improprio o abuso (strappi, bruciature e fori). L'uso intensivo in ambiente aggressivo (mare e piscina), richiede un regolare risciacquo del tessuto con acqua dolce per prevenire ed evitare l'accumulo di residui salini e clorurati.

2 anni di garanzia su tutti gli elementi metallici e in acciaio in genere

1 anno di garanzia sui meccanismi di apertura con manovella, previo uso corretto e rispettoso delle istruzioni fornite.

2 anni di garanzia in genere per le finiture e altri materiali non specificatamente menzionati e scritti sopra, comprese le basi in cemento e le zavorre

1 anno di garanzia sui kit luci LED e sui componenti elettrici in general.

LA GARANZIA NON SI APPLICA:

- Se il prodotto non è stato assemblato secondo le istruzioni fornite;
- in caso di uso improprio del prodotto o non conforme alla normale destinazione d'uso del bene;
- in caso di mancato rispetto delle istruzioni per l'uso e la manutenzione indicate nel materiale informativo fornito con il prodotto;
- in caso di stoccaggio in condizioni ambientali non idonee al prodotto;
- in caso di modifica o manomissione del prodotto;
- se il prodotto è stato assemblato o combinato con componenti e prodotti non forniti da Scolaro.

Per usufruire della garanzia è necessario esibire l'articolo difettoso o inviare le foto, unitamente alla fattura o scontrino fiscale.

La garanzia comprende la fornitura di parti di ricambio o la sostituzione del prodotto se necessario. La garanzia non comprende la riparazione in loco o il rimborso delle spese sostenute per il mancato utilizzo del prodotto.

In caso di vizio accertato da Scolaro, si riserva il diritto - a propria discrezione - di sostituire il prodotto con uno uguale o equivalente per caratteristiche essenziali o di rimborsare al cliente solo l'importo pagato per il prodotto. Nessuna ulteriore spesa o danno potranno essere richiesti a Scolaro.

Scolaro non sarà responsabile per eventuali danni a cose o persone derivanti da un uso improprio del prodotto.

Politica di servizio e riparazioni

Anche in caso di danneggiamenti e rotture, Scolaro ha sempre adottato un'attenta e puntuale politica di assistenza post vendita.

In qualunque caso di danneggiamento o necessità, consigliamo di contattare la nostra azienda per valutare la possibilità di riparare e recuperare il prodotto, nonché per ottenere assistenza per eseguire l'intervento.

La corrispondenza ad alti standard qualitativi e funzionali dei materiali impiegati costituisce la garanzia principale della robustezza e resistenza nel tempo dei prodotti Scolaro. Un comportamento rispettoso di norme di manutenzione ed uso, come specificato di seguito, assicura una durata ancora maggiore.

Le informazioni contenute in questo catalogo o in altri stampati pubblicitari della ditta Scolaro, quali caratteristiche tecniche dei prodotti o dei componenti, dimensioni, schemi di montaggio, colori, ecc., hanno valore meramente indicativo, in ragione delle specifiche tecniche e della evoluzione tecnologica dei prodotti aziendali. Al fine di migliorare la qualità del prodotto, la ditta si riserva il diritto di modificare lo stesso senza alcun preavviso e anche dopo l'accettazione dell'ordine. L'azienda si riserva di apportare modifiche parziali o totali ai prodotti senza preavviso declinando ogni responsabilità su eventuali dati inesatti. Eventuali lievi variazioni di tonalità dei colori e delle finiture rientrano nelle normali caratteristiche dei materiali impiegati. Tutte le differenze sopraindicate non sono tali da modificare significativamente i prodotti stessi e non costituiscono motivo di reso o sostituzione della merce o di contestazione.

USE AND MAINTENANCE

DIRECTIONS

- Before use, directions and assembling instructions, which are inside the package, have to be kept and read carefully.
- The base has to be ballasted. An insufficient weight will seriously compromise the stability of the parasol.
- Always remove crank when not in use and keep out of reach of children.
- To avoid damage or personal injury, parasol must be closed and in some extreme weather conditions it may be necessary to remove the product and store it in a protected place. Remember always that the parasol is not a fixed construction. The company Scolaro cannot be held responsible for damages to goods supplied, or injury resulting from improper use and failure to follow instruction and guidelines given on.

PRODUCT EMPLOY

Before starting to open the parasol, make sure that the fabric has not got caught in the internal ribs. To open or close the parasol, turn the handle (where available) in the direction indicated by the arrows and the words "Open" or "Close". Incorrect operation could tear the string or damage the mechanism. Never force the ropes or handles. If they get stuck, check why this has happened and eliminate the possible cause. Wooden parts: apply a wax-based wood-stainer at least once a year before the winter season. Close the parasol when the weather conditions are unsuitable, strong wind or heavy rain. Scolaro parasols can be combined with special bases developed for the ground fixing. If it is decided to position a Scolaro parasol using ballast only, their suitability for use in conditions of moderate wind is certified. In the specific table the minimum ballast weights are indicated. The Customer is the sole party responsible for installing and managing the parasol.

STAINLESS STEEL

Attention:

1. DO NOT USE THE FOLLOWING PRODUCTS on any parts made of stainless steel: Chlorine bleach or detergents containing bleach (they can corrode stainless steel). Hydrochloric acid or products containing chlorides (they can corrode stainless steel).
2. Salt, limestone or acids (drinks and food) may discolour parts made of stainless steel if not cleaned promptly.
3. Products or parts made of stainless steel used near the seaside or for the interior decoration of swimming pools require more frequent cleaning in order to remove chlorites deposited on them and to prevent corrosion and chemical deterioration of the external surfaces.
4. Stains or rust noted on stainless steel surfaces must be cleaned promptly.
5. Stains left in place for long periods may become permanent.
6. Rust may cause chemical reactions or corrode stainless steel.

To remove stains or rust:

- Apply a specific non-abrasive detergent or polish for stainless steel.
- Rinse thoroughly with clean water.
- Lastly, dry thoroughly in order to prevent streaks from occurring, rubbing in the sense of the fibres.

VARNISHED METALS: IRON AND ALUMINIUM

For a long lasting of the parasol we recommend to store it in dry environments, during the winter and when not in use. It's also recommended to check once a season, especially after a long period of inactivity, the proper functioning of all components. Our warranty does not cover any type of scratches or abrasions to finish caused from the contact with other furniture or any resulting corrosion. The employ in marine environments can lead to the accumulation of salt and chlorides on the powder coating. Failure to perform regular cleaning with fresh water can cause blisters, oxidation, discoloration and invalidates the warranty. To clean surfaces in varnished metals, use cold water and non abrasive or aggressive liquid detergents. Apply with a soft cloth. In the case of very dirty and/or aged surfaces, after cleaning, it is advisable to treat them with liquid paraffin. In the event of stains caused by lime deposits on varnishes of coarse structure (eg. antique iron and indian brown) clean them with a cloth and a solution of white wine vinegar diluted in cold water.

WOOD: IROKO

Traditional wood employed for outdoor furniture and the marine industry. Iroko is a hardwood with a high oil content, suitable for external use. Extremely long-lasting. It is practically unalterable to repeated exposure to atmospheric factors. Even if treated, the surface takes a silver-grey coating which is the natural protection from inside the wood, considered an essential part of Iroko's charm. The natural tendency of wood to turn gray or lose the brightness of the paint can be prevented in the early stages of the product life. The parasol can be restored by a new treatment with proper products easy to find in specialized shops. It's necessary to apply a solution of water and colourless oil, to exposed surfaces with a cloth. The oil must be highly diluted. Superficial stains can be removed by intervening in time, before the wood can fully absorb them. Gently sand the surface in question and then polish with a rough cloth.

SYNTHETIC FABRICS: ACRYL AND POLYESTER

The fabric is waterproof and anti mould treated to reject water, spots and grant transpiration. Please follow our maintenance instruction to grant the long lasting of the fabric:

- Remove often dust deposits, spots and any type of dirt in order to avoid trails after cleaning.
- It's very important to close the parasol only when it is perfectly dry. During the winter and when the parasol is not employed, it has to be stored in dry environment. Avoid prolonged contact with oily substances and/or dyes that could be absorbed by the covering material in PVC and cause permanent stains, in addition to damaging the structure of the thread. Do not use solvents or solvent-based detergents (avoid acetone). Use water and non-abrasive, colourless liquid detergents with a neutral PH. Let the detergent act for a few minutes. Rinse well with water no warmer than 30°C.

COMPONENTS

The steel components, screws and accessories are anti rust treated. Anyway for a long lasting of the parasol, during the winter and when the it is not employed, the parasol has to be stored in dry environment. During every season it is necessary to check the functionality of all components, especially after a long period of non-employ. The company Scolaro is at your disposal for technical assistance.

WARRANTY

Scolaro parasols are designed to last for many years exposed to outdoor use.

As with many items, attention in use and maintenance and following the instructions contained in these pages, allows an even longer average life of the product and the possibility of enjoying an even more efficient and aesthetically pleasing product.

Scolaro's products are guaranteed for 2 years. If you comply with the indications and advices, the warranty can be extended as follows:

THE WARRANTY COVERS ONLY MANUFACTURING DEFECTS OF STRUCTURAL INTEGRITY. THE WARRANTY DOES NOT COVER DAMAGES CAUSED BY MECHANICAL ACTIONS, FORCE OF NATURE AND MALICIOUS ACTS.

5 years warranty on aluminum and stainless steel components. Including painting and screws.

- Structural faults not resulting from improper use or lack maintenance.
- Invasive corrosion not produced by scratches or abrasions from use not removable through normal cleaning and maintenance.

5 year warranty on colors and treatment of fabrics (strength).

- The replacement of the canopy during the warranty period is foreseen only if it loses its color before the end of the warranty period. Users must properly maintain fabrics for the warranty to be effective. Proper maintenance implies regular cleaning.
- The warranty does not cover damage from contact with foreign objects, wind-driven abrasions, misuse or abuse (tears, burns and holes). The intensive employ in an aggressive environment (seaside and pool use), requires a regular rinse of the fabric with fresh water in order to prevent and avoid the build-up of salt and chloride residues.

2 years warranty on all metal and steel elements in general

1 year warranty on the opening mechanisms with crank subject to correct and respectful use according to the instruction given.

2 years warranty in general for finishes and other materials not specifically mentioned and written above, including concrete bases and ballasts.

1 year warranty on LED light kits and electrical components in general. THE WARRANTY DOES NOT APPLY:

- If the product has not been assembled according to the instructions provided;
- in the event of improper use of the product or use that does not conform to normal intended use of the property;
- in case of non-compliance with the instructions for use and maintenance indicated in the information material supplied with the product;
- in case of storage in environmental conditions that are not suitable for the product;
- in case of modification or tampering with the product;
- if the product has been assembled or combined with components and products not provided by Scolaro.

To take advantage of the warranty the faulty item must be shown or pictures must be forwarded, together with the invoice or receipt.

The warranty includes the supply of spare parts or the replacement of the product if necessary.

The warranty does not include the repair on-site or the refund of costs incurred for non-use of the product. In case of defect confirmed by Scolaro, it reserves the right - at its own discretion - to replace the product with an equal or equivalent one for essential characteristics or to refund only the amount paid for the product to the customer.

No further expenses or damages can be requested from Scolaro. Scolaro will not be liable for any damage to properties or individuals deriving from an improper use of the product.

Service and repairs policy

Even in the event of damage and breakage, Scolaro has always adopted a careful and punctual after-sales assistance policy.

In any case of damage or need, we recommend contacting our company to evaluate the possibility of repairing and recovering the product, as well as to get assistance in carrying out the intervention.

The connection between the high qualitative and functional standards of the materials used, constitutes the main guarantee of the sturdiness and the resistance of the company's products over time. Respecting the rules of maintenance and use, specified as follows, will ensure the success of these objects, which were devised with Scolaro quality, to last a long time.

The information contained in this brochures or other Scolaro's advertisements prints, such as product specifications or components, dimensions, assembling instruction, colours, etc., are purely indicative, because of the technical specifications and the technological evolution of the company's products. In order to improve the quality of the product, the company reserves the right to change the same without prior notice and even after acceptance of the order. The company reserves the right to make partial or complete changes to the products without prior notice and declines any responsibility for inaccurate data. Any colour differences and changes of finishing have to be considered normal characteristics of the materials used. These differences do not significantly change the products and aren't reason for return or replacement of the goods or dispute.



- Dimensione (metri)
- Dimensions (meters)
- Masse (Meter)
- Dimensions (mètres)
- Dimensiones (en metros)
- Afmeting in (meters)



- Lunghezza
- Length
- Laenge
- Longueur
- Longitud



- Peso
- Weight
- Gewicht
- Poids
- Peso
- Gewicht



- Volume (m³)
- Volume (m³)
- Volumen (m³)
- Volume (m³)
- Volumen (m³)



- Ø Palo (mm)
- Ø Pole (mm)
- Ø Mast (mm)
- Ø Mat (mm)
- Diametro mm (asta)
- Ø Mast (mm)



- Sezione sostegno (mm)
- Support section (mm)
- Mastprofil (mm)
- Section support (mm)
- Sección soporte (mm)
- Mast (mm)



- Colore dei componenti/stecche
- Component/Ribs colour
- Farbe der Bestandteile und Streben
- Couleur des composants et baleines
- Color de los componentes ò piezas/Varillas ò listones



- Stecche
- Ribs
- Streben
- Baleines
- Varillas
- Baleinen



- Set canaline
- Raingutter set
- Regerinnen
- Set gouttières
- Canalizador Lluvias
- Set regengoten

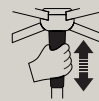

- Apertura semplificata a spinta
- Easy push opening system
- Vereinfachte push-up Oeffnung
- Ouverture par poussée simplifiée
- Apertura por empuje simplificada
- Eenvoudig push-up systeem voor openen en sluiten



- Sezione stecche
- Rib section
- Strebenprofil
- Section baleines
- Sección varillas
- Profiel baleinen



- Camino antivento
- Wind cap
- Windfang
- Souffle
- Chimenea antiviento
- Windvang



- Stecca con sistema "easy change"
- Ribs with "easy change" system
- Streben mit "easy change" System
- Baleines avec "easy change" système
- Varillas con sistema de " cambio fácil"
- Baleinen met het "easy change" systeem



- Blocco antivento
- Wind stop
- Windstop
- Block antivent
- Freno para el viento
- Windstop



- Con meccanismo manovella
- With winding mechanism
- Mit Kurbelmechanismus
- Avec mécanisme manivelle
- Con manivela
- Met opwindmechanisme



- Piastre cemento
- Cement slabs
- Kiesbetonplatten
- Dalles ciment
- Planchas de cemento
- Betontegel



- Fodero
- Cover bag
- Schutzhuelle
- Housse
- Forro
- Afdekhoes



- Doppia carrucola
- Double pulley
- Doppelter Seilzug
- Double poulie
- Doble polea
- Dubbele katrollen



- Sistema telescopico
- Telescopic system
- Teleskopsystem
- Système telescopique
- Sistema telescópico
- Telescoop systeem



- Sistema retrattile
- Retractable system
- Einziehbares System
- Système retractile
- Sistema retráctil
- Inklapbaar systeem



- Ombrellone girevole a 360°C
- 360-degree rotating umbrella
- 360° drehbarer Schirm
- Parasol rotatif à 360°
- Parasol giratorio de 360°
- 360° draaibare parasol



- Inclinazione fino a 20°
- Inclination up to 20°
- Neigung bis zu 20°
- Inclination jusqu'à 20°
- Inclinación hasta 20°



- Inclinazione fino a 60°
- Inclination up to 60°
- Neigung bis zu 60°
- Inclination jusqu'à 60°
- Inclinación hasta 60°

INOX

- Viteria in inox
- Screws in Stainless steel
- Edelstahlschrauben
- Visserie inox
- Tornillos en acero inoxidable
- Schroeven van rvs



- Tipo finitura della struttura/sostegno/componenti
- Finishing for frame/structure/components
- Ausfuehrung des Gestells/der StrENtur/der Bestandteile
- Finition armature/structure/composants
- Tipo de acabado de la estructura/Soportes/ componente